

---

# BRISTAN

TAPS & SHOWERS

## Installation Instructions and User Guide

Artisan Evo

Digital Electronic Mixer

Shower

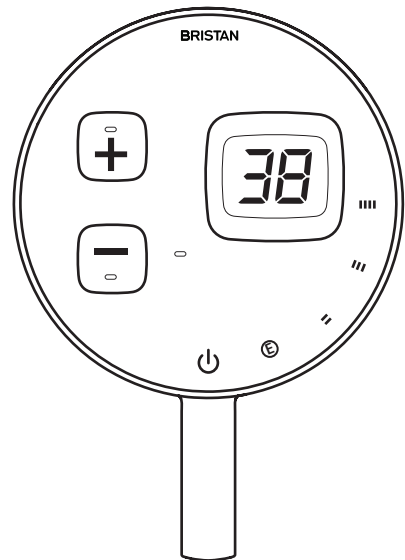

**Models covered:** ARDE SHCCF W,  
ARDE SHCCF B & ARDE SHCCFM C

Please keep this booklet for future  
reference.

Installer, when you have read these  
instructions please ensure you leave  
them with the user.

# Contents

Welcome to your new Bristan Digital Electronic Mixer Shower, featuring a contemporary design, wireless electronic controller and digital mixing unit.

Bristan's Digital Electronic Mixer Shower has been designed to be easy to install and use. It has also been designed and tested in the UK to all of the relevant British Standards.

These instructions are for your guidance to a safe and successful installation, so please read them thoroughly and retain for future reference.

We recommend the installation is carried out by a suitably qualified person and must conform with current I.E.E Wiring Regulations (BS7671) and Building Regulations (Part P and Part G).

Important Safety Information .....	3
General Information .....	4
Pack Contents .....	5
Tools Required .....	5
Product Features .....	6
Specifications .....	7
Dimensions .....	8
Installation Requirements .....	9-11
Positioning the Mixer Valve .....	9
Water Requirements .....	10
Electrical Requirements .....	11
Installation .....	12-17
Fitting the Mixer Valve .....	12
Water Connections .....	13
Electrical Connections .....	14
Fitting the Wireless Controller .....	15
Shower Arm & Rose.....	16-17
Commissioning .....	18-20
Wireless Initialisation & Pairing .....	18-19
Maximum Temperature Setting .....	19
Water / Plumbing Connections .....	20
Purge Procedure .....	20
Basic Functional Testing .....	20
Operating the Shower .....	21-22
Maintenance .....	23-25
Troubleshooting .....	26-27
Spare Parts .....	28
Notes .....	29
Guarantee .....	30-31

# Important Safety Information

- Please read these instructions thoroughly and retain for future use.
- All products manufactured and supplied by Bristan are safe provided they are installed, used correctly and receive regular maintenance in accordance with these instructions.
- **If you are in any doubt about your ability to install this product safely you must employ the services of an experienced qualified plumber / electrically qualified person.**
- This Digital Electronic Mixer Shower needs to be installed in accordance with, and meet the requirements of the Water Supply (Water Fittings) Regulations 1999 and Scottish Byelaws 2004.
- Before starting any installation please consider the following:
  - Before drilling into walls, check that there are no hidden electrical wires, cables or water supply pipes. This can be checked with the aid of an electronic detector.
  - If power tools are used do not forget to:
    - Wear eye protection
    - Unplug equipment after use
- **⚠ Warning:** Before installing the new Digital Electronic Mixer Shower it is essential that you thoroughly flush through the pipework in order to remove any remaining swarf, solder, etc. Failure to carry out this procedure could cause problems or damage to the workings of the Mixing Valve.
- Do not operate the shower if the water stops flowing during use or if the water is leaking from the Mixing Valve itself. Turn off at the mains electrical supply and refer to the Troubleshooting section (see pages 26-27) or contact Bristan Customer Services on 0844 701 6273.
- Do not block the flow of water from the shower rose by smothering it on your hand or any other part of your body or foreign object.
- **⚠ Warning:** Do not operate this product if you suspect it is frozen. Do not site the Mixing Valve where it might be subjected to freezing conditions.



0359

BEAB (British Electrotechnical Approvals Board) approval of safety.









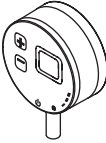

Hereby, Bristan Group Ltd, declares that this Electronic Mixing Valve with Wireless Controller is in compliance with the essential requirements and other relevant provisions of the Directive 1999/5/EC. The declaration of conformity may be consulted at [www.bristan.com/dop](http://www.bristan.com/dop).

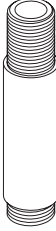
# General Information

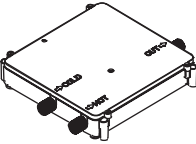

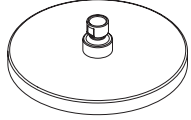
- Remove all packaging and check the contents for damage before starting any installation.
- Fitting isolation valves to the inlet feeds is required as close as is practical to the inlet connections for ease of maintenance.
- Always switch off the power at the consumer unit and isolate the electrical supply before making any electrical connections or if you have to remove the cover of the Mixing Valve.
- This product **must not** be modified in any way as this will invalidate the guarantee.

Recommended Usage			
Domestic	✓	Heavy Commercial	✗
Light Commercial	✓	Health Care	✗

# Pack Contents & Tools Required

 <p>Wireless Controller x1</p>	 <p>Wall Plugs x7</p>	 <p>Arm x1</p>	 <p>Shroud x1</p>
 <p>Mixing Valve x1</p>	 <p>Batteries x2</p>		 <p>Rose x1</p>
	 <p>Remote Control Screw x3</p>	 <p>Sealing Washer x1</p>	
	 <p>Mixing Valve Screw x4</p>		

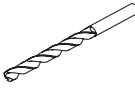
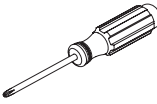
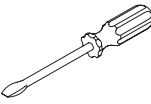
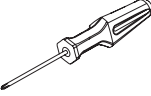
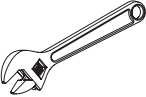
## Tools Required - Not supplied

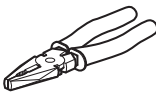
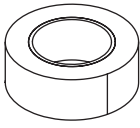
 <p>Drill</p>	 <p>Suitable Drill bit</p>	 <p>Phillips Screwdriver</p>	 <p>Flat Head Screw Driver</p>	 <p>Electrical Screwdriver</p>
 <p>Spanner</p>	 <p>Pencil</p>	 <p>Electrical Tester</p>	 <p>Electrical Pliers</p>	 <p>Masking Tape</p>

# Product Features

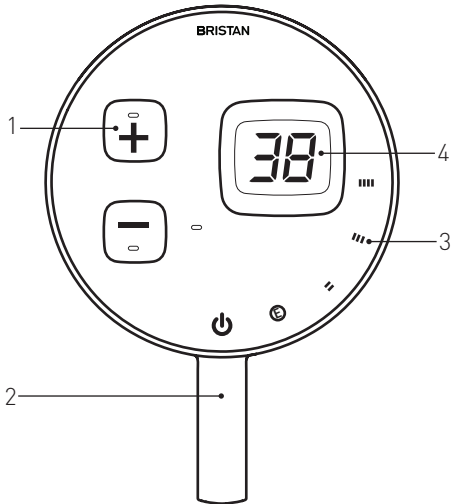

## 1. Temperature control

Press **+** to increase the temperature up to a factory set maximum of 48°C (the maximum temperature can be overridden, see Maximum Temperature Setting on page 19).

Press **-** to decrease the temperature down to a minimum of 35°C.

## 2. Lever handle

Turns the shower on and adjusts the flow of water. Turn anti-clockwise to turn the shower on and back to **⏻** to turn the shower off.

## 3. Water flow settings

The shower has 4 flow settings. Eco (**E**), Low (**II**), Medium (**III**), and High (**IIII**).

## 4. Digital display screen

Displays the water temperature **38**. Any error codes will be displayed on here.

## 5. Time out setting

If the shower valve has been running for 30 minutes the Mixing Valve will automatically shut off to save water and energy.

Normal use will be resumed once the lever handle has been returned to the 'Off' position.

## 6. Memory function

(ARDE SHCCFM C variant only)  
Allows two temperature and flow pre-sets to be stored and used for quick control.

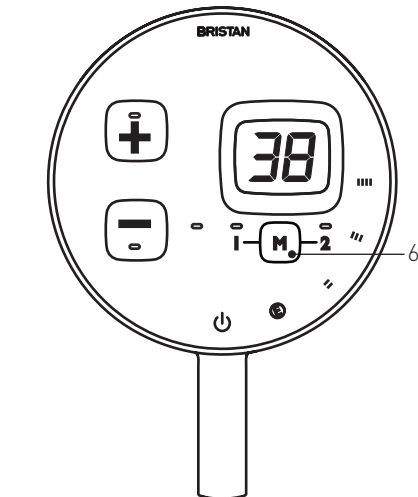

**Note: Artisan Evo is designed for only one controller; it is not possible to add a second controller**

# Specifications

## Water Supply Requirements

**Inlet connections:** 1/2" BSP with 70mm between centres.

**Operating pressure range:** Min. 0.5 bar - Max. 5.0 bar

For optimum performance a minimum dynamic working pressure of 1.0 bar is required. (If the inlets are pumped, a Bristan Twin-End Negative Head Pump - ST NHPUMP 18TN must be used).

**Minimum static pressure:** 0.5 bar

**Maximum static pressure:** 10.0 bar

### Supply requirements:

Minimum cold water supply temperature: 5°C.

Maximum cold water supply temperature: 20°C.

Minimum hot water supply temperature: 52°C.

Maximum hot water supply temperature: 65°C.

## Flow Performance

Flow Setting	Optimum Flow Rate (lpm)
Ⓔ	6 lpm
	8 lpm
	10 lpm
	12 lpm

## Electrical Supply Requirements

**Supply voltage:** 230V AC / 35W

# Dimensions (mm)

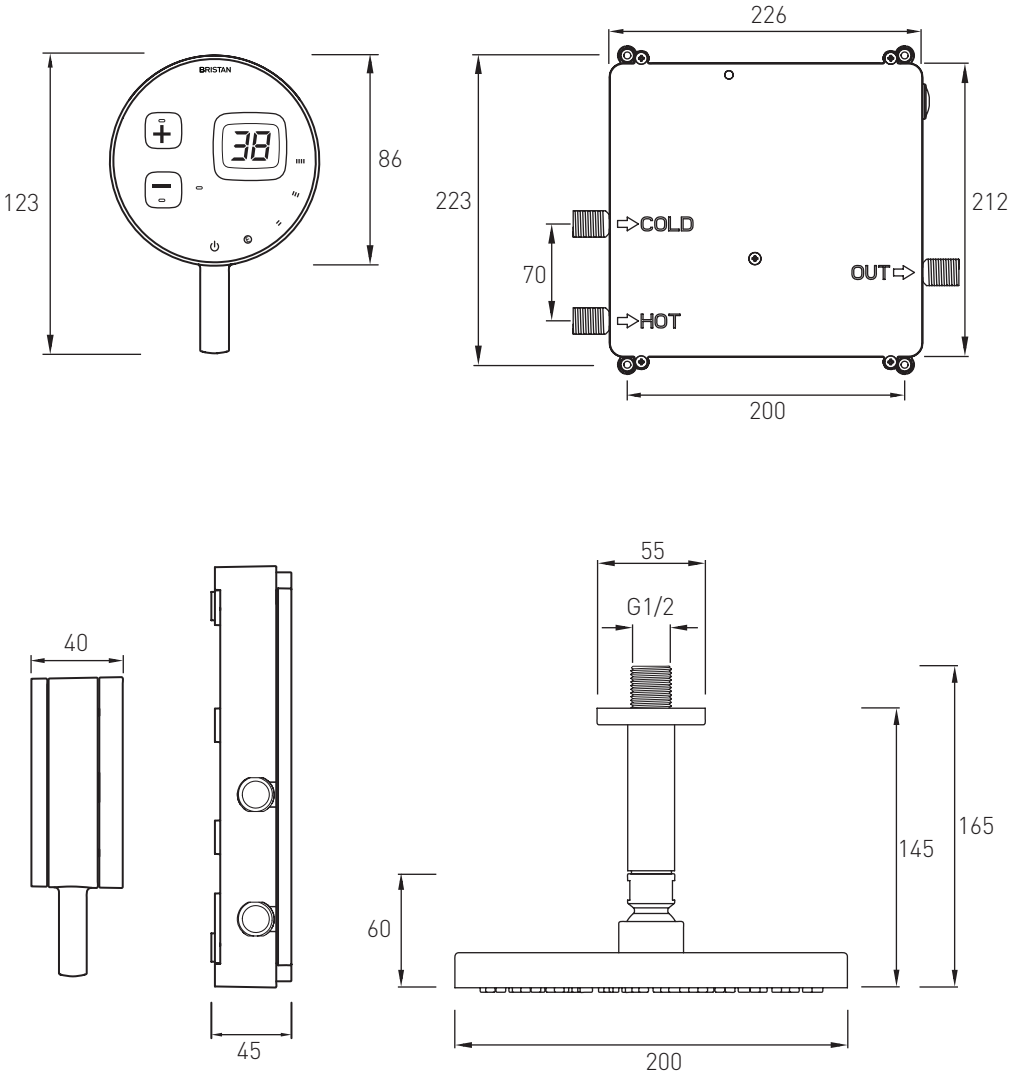



# Installation Requirements

## Positioning the mixing valve

The Mixing Valve can be positioned on either a wall surface or flat on the floor. (Refer to the diagrams for the correct orientation of the Mixing Valve).

The Mixing Valve can be installed in either an airing cupboard, loft space or under the bath. **Do not** site the Mixing Valve where it may be subjected to freezing conditions or ambient temperatures over 40°C.

The maximum distance from the Mixing Valve to the Wireless controller **must not** exceed 10 metres as this is beyond the operating range of the wireless controller.

## Wireless installation considerations

As with any wireless / radio product:

- Metallic lined materials or metal objects (such as steel baths or metal tanks, etc.) can significantly reduce the operating range of the wireless interface or prevent operation.

- Interference from other radio signals has the potential to affect the ability of the wireless interface to function correctly.

**Note:** If the Mixing Valve loses wireless communication with the controller, the shower will automatically turn off safely.



Flat on the floor

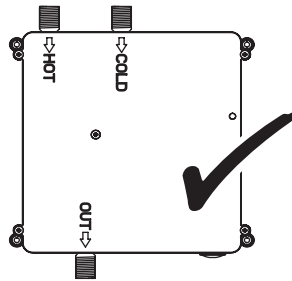

Vertically down on the wall

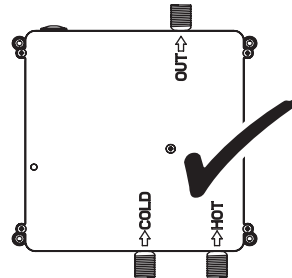

Vertically up on the wall

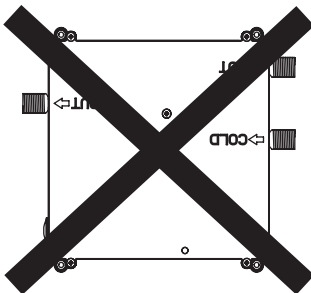

**DO NOT INSTALL UPSIDE DOWN ON THE WALL!**

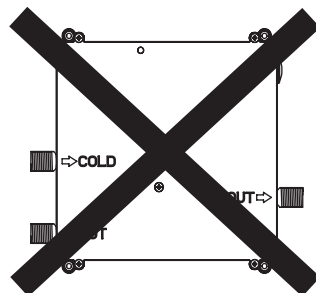

**DO NOT INSTALL HORIZONTALLY ON THE WALL!**

# Installation Requirements

## Water Requirements

This fitting needs to be installed in accordance with the following Installation Requirements and Notes (IRN) to ensure they meet the requirements of the Water Supply (Water Fittings) Regulations 1999 and the Scottish Byelaws 2004.

The fitting shall be installed so that its outlet discharges above the spill-over level of any appliance as indicated on the illustration below.

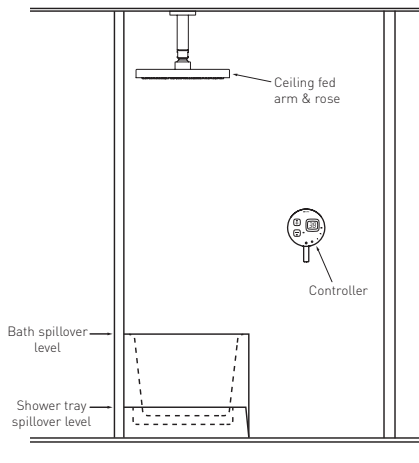

## For backflow protection in premises or installations up to, and including Fluid Category 3 and 5.

The vertical distance of the outlet above the spill-over level shall be not less than 20mm or twice the diameter of the inlet pipe to the fitting, whichever is the

greater. If the fitting cannot be installed as indicated it shall be installed with a backflow prevention arrangement suitable for the Fluid Category.

If the shower is to be installed in a hard water area, we recommend that an in-line scale inhibitor is fitted which will prolong the life of the shower. Please refer to your supplier for advice.

**⚠ Warning: the shower must not be installed in an area subject to freezing conditions. Do not use if you suspect the shower is frozen, this will damage the shower unit.**

**Maximum ambient temperature: 40°C.**

**A minimum working inlet pressure of 0.1MPa (1bar) at a minimum flow rate of 10 litres per minute is recommended for full performance.**

**The maximum static inlet pressure must not exceed 1.0MPa (10bar).**

If it is intended to operate the shower above the recommended operating / dynamic pressure, a suitable pressure reducing valve (PRV) should be used.

Water regulations stipulate that a removable showerhead be constrained by a fixed or sliding attachment (hose retainer supplied) so that it can only discharge water at a point not less than 20mm above the spill-over lever of the bath or shower tray or other fixed appliance.

# Installation Requirements

**Note:** If a showerhead can sit within a bath, basin or shower tray, Water Regulations stipulate a double check valve must be fitted in the supply pipe work to prevent back siphonage\*. If the showerhead can sit within a WC then the air gap should be a type AUK3 not less than 20mm or twice the diameter of the inlet pipe to the fitting, whichever is the greater.

\* As this shower unit is already supplied with a single check valve pre-fitted in each water supply inlet, a further single check valve would be required in such a situation, fitted in each water supply as close as possible to the existing check valves.

## Electrical Requirements

 **Warning: This appliance MUST be earthed!**

Power Rating: 230V AC / 35W

The Electrical Installation and Curcuit Protection of this shower must comply with current I.E.E Wiring Regulations (BS 7671) and Building Regulations (Part P). We recommend that this Digital Electronic Mixing Shower is installed by a qualified electrician prior to use. The following notes are for your guidance only.

**Important:** You **must** switch off the power at the consumer unit, isolate the electrical circuit and verify the earth before making any electrical connections.

The Mixing Valve must only be connected to a 230-240 V AC supply.

This product must be connected to a fused spur with double-pole isolation and a 3A fuse.

It is recommended that a residual current device (RCD) formerly known as an earth leakage circuit breaker (ELCB) with a tripping current of 30mA, incorporated in the circuit. This may be part of the existing consumer unit or a seprate unit.

For close circuit protection **DO NOT** use a rewireable fuse. Instead use a suitably rated miniature circuit breaker (MCB) or Cartridge Fuse.

Do not turn on the electrical supply until the plumbing has been completed and the Mixing Valve cover re-fitted (if removed).

# Installation - Mixing Valve

## Fixing the Mixing Valve to the floor / wall

Please refer to Positioning the Mixing Valve on page 9 before starting any installation.

The Mixing Valve needs to be installed on either a flat floor or a wall surface.

Position the Mixing Valve on the floor or wall surface and mark all 4 fixing points.

**⚠ Warning:** Please check for any hidden pipes and cables before drilling holes into the floor / wall.

If you are fitting the Mixing Valve to a partition wall, a wall of particularly friable (crumbly) substrate or a wooden floor you will need appropriate fixings for the floor / wall type.

Drill suitable holes in the floor / wall surface at the marked positions and insert wall plugs (if required).

Secure the Mixing Valve to the floor/wall surface using the fixings supplied or suitable fixings dependant on floor / wall type.

**Important:** Under no circumstances should the mixing valve be recessed as this may prevent air circulating and condensation escaping.

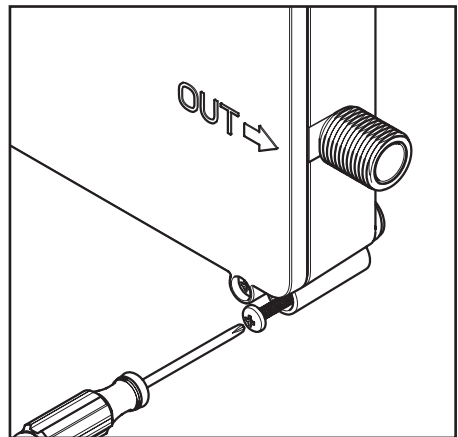
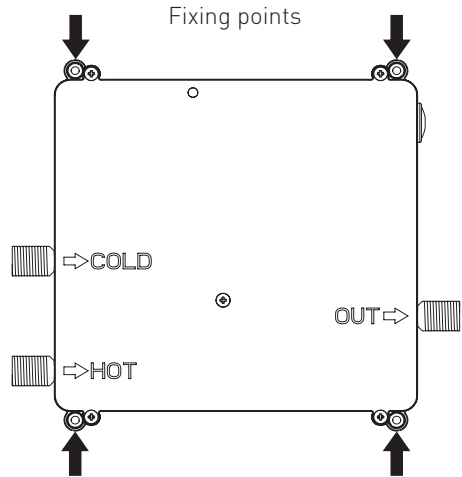

# Installation - Water Connections

## Plumbing Connections

 **Warning:** Do not solder within 300mm of the Mixing Valve or allow solder or flux to fall onto the casing.

**Important:** An additional independent stop valve complying with the current water regulations must be fitted in the mains water supply as a means of isolating the supply to the Mixing Valve for servicing and / or maintenance work.

It is essential that all pipe work is flushed through to remove debris and swarf that could otherwise damage the unit. Once the pipework has been flushed through, turn off the water supplies at the stop / service valves.

The supplied filter washers supplied **must** be fitted into both inlets.

The connecting pipework must present 1/2 BSP connectors to the male thread on the inlet connections.

**Important:** The pipework must run as straight as possible to the Mixing Valve minimising 90° angled bends as this could affect the inlet pressure to the Mixing Valve reducing performance.

## Pumped Inputs

It is possible to use a pump to boost a low pressure system to meet the inlet requirements.

**Note:** The pump must be a Bristan Twin-End Negative Head Pump - ST NHPUMP 18TN.

Pump installation must be in accordance with the Fitting Instructions supplied with the pump.

The Negative Head Pump is required to maintain the 0.5 bar minimum static pressure requirement.

# Installation - Electrical Connections

## Electrical Connections

The electrical installation must be carried out in accordance with the current I.E.E Wiring Regulations (BS 7671) and Building Regulations (Part P).

 **Warning:** This appliance and all connecting metal pipework must be earthed via the supply cord, which must be correctly connected to the earth point located in the terminal box.

The Mixing Valve must be permanently connected to the fixed wiring of the mains supply using the factory fitted supply cord, via a double pole switched fused spur off the ring main.

In the interests of electrical safety a 30mA residual current device (R.C.D. not supplied) should be installed in the supply circuit. This may be part of a consumer unit or a separate unit.

## Wiring of connection unit:

 **Warning:** This appliance must be earthed.

The wires in the mains lead are coloured in accordance with the following code:

Green and Yellow	Earth
Blue	Neutral
Brown	Live

As the colours of the wires in the mains lead of this appliance may not correspond with the coloured markings identifying the terminals in your connection unit proceed as follows:

- The wire which is coloured green and yellow must be connected to the terminal in the connection unit which is marked with the letter E or by the earth symbol or coloured green or green and yellow.
- The wire which is coloured blue must be connected to the terminal which is marked with the letter N or coloured black.
- The wire which is coloured brown must be connected to the terminal which is marked with the letter L or coloured red.

# Installation - Wireless Controller

## Fitting the Wireless Controller

Remove the locking ring and wall bracket from the wireless controller by twisting the locking ring clockwise.

Position the wall bracket onto the finished wall surface and mark the fixing holes.

Drill holes at the marked positions on the wall surface using a suitable drill bit for the fixings.

**⚠ Warning:** Please check for any hidden pipes and cables before drilling holes in the wall.

### Tips:

A piece of insulation or masking tape positioned where holes are to be drilled and before marking out the exact position for the fixing holes will help stop the drill bit from wandering, particularly on a tiled surface.

When working near a basin, bath or shower insert plug or cover waste to prevent losing small parts.

Take care not to drop tools/equipment into basin, bath or shower during installation.

Secure the wall bracket to the wall using the fixings supplied or suitable fixings for the wall type, ensuring the locking ring is positioned behind the fixing bracket.

Once the wall bracket is secured to the wall surface turn the locking ring so that one of the four fixing lugs is at a 12 o'clock position.

Fit the remote control onto the locking ring. Twist the locking ring anti-clockwise to lock the remote control into position.

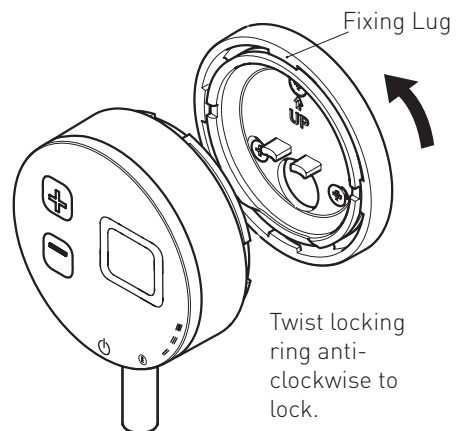
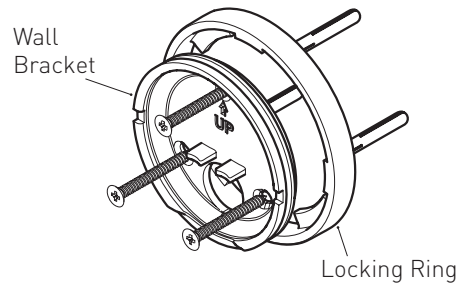
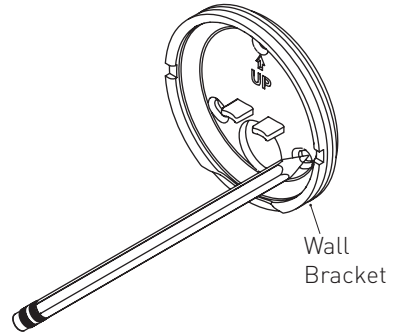

# Installation - Ceiling Fed Arm & Rose

## Fitting the Ceiling Fed Arm & Rose

Before proceeding with fitting the ceiling fed arm and rose, suitable 15mm supply pipework must be installed above the ceiling / in the loft area, from the Mixing Valve to the desired location of the arm.

**⚠ Important:** The pipework **must** be rigid / fixed to a joist or beam to ensure it does not move.

See opposite for examples of pipework installation.

Either a brass union 1/2" compression x 1/2" M/F or a brass union elbow 1/2" compression x 1/2" F/M fitting should be used at the end of the supply pipework to allow connection of the ceiling fed arm.

**Note:** When installing the brass union fitting take into consideration the length of the thread on the arm and the thickness of the ceiling / plasterboard.

Pipework secured to the top of a beam / joist

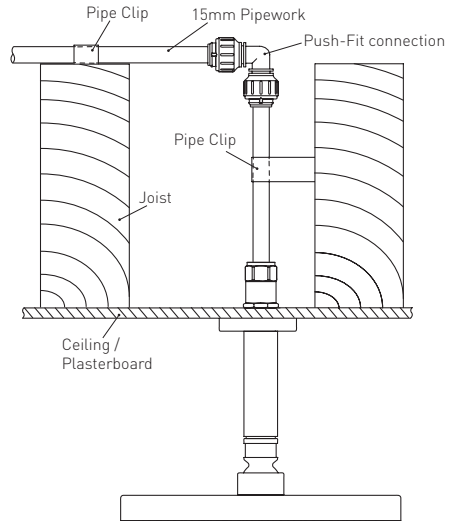

Pipework secured to the side of a beam / joist

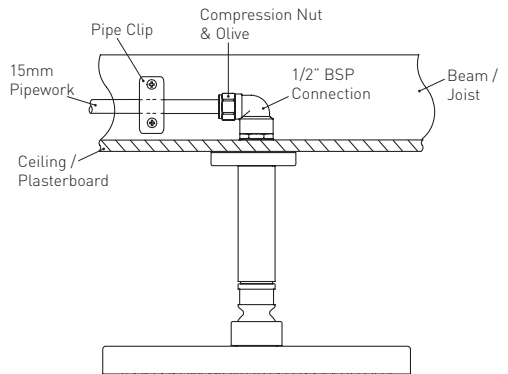



# Installation - Ceiling Fed Arm & Rose

Drill a 25-30mm hole in the ceiling / plasterboard at the required position for the shower arm.

Screw the shroud onto the top thread of the arm.

Place the top thread of the arm through the hole in the ceiling / plasterboard and secure in place using a G1/2 backnut.

Using a suitable thread sealant connect the brass union fitting to the thread of the arm.

Note: The shroud should be flush against the ceiling / plasterboard to hide the hole.

Screw the shower rose onto the lower thread of the arm, ensuring the sealing washer supplied is fitted between the thread and the rose connection.

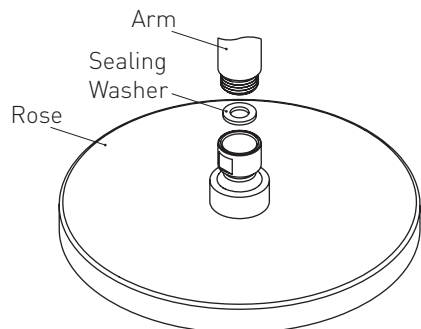
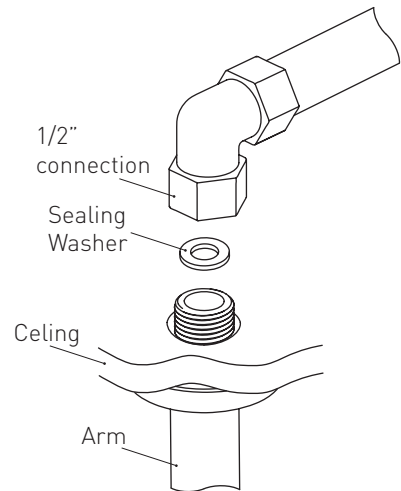
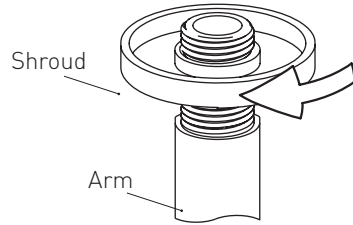

# Commissioning - Wireless Connection

## Wireless Initialisation & Pairing of the remote control to mixing valve



For the wireless communication to work, the Remote Control needs to be initialised and paired with the Mixing Valve. This is pre-configured upon manufacturing of the product, so the product should work "out-of-the-box".

### 1. Check the Wireless Communication is configured correctly.

Ensure the Remote Control is equipped with the 2 x AA batteries supplied and the flow lever is in the  position (6 o'clock).

Isolate both hot and cold water supplies to the Mixing Valve and turn the power to the Mixing Valve off.

**1.1.** Power on the Mixing Valve. The LED will initially show "Green". Wait for ~30 seconds, the LED will show "Yellow" to indicate "No wireless connection".

**1.2.** Turn the Remote Control "on" by turning the flow lever to "eco"  position (5 o'clock). The Mixing Valve LED should return to "Green" in a few seconds to indicate wireless communication. Turn the Remote Control "off" by turning the lever back to  and turn the power off to the Mixing Valve.

If the Mixing Valve LED returns to "Green", the product is Initialised and Paired correctly and no further action is required.

If the Mixing Valve LED stays "Yellow", the Wireless Connection is not configured correctly. Proceed with the Initialise (2) and Pairing (3) steps.

Additionally, it may also be necessary to perform the Initialisation and Pairing (Steps 2 & 3), if:



- You have a replacement unit (either the Mixing Valve or Remote Control).
- The pre-set address used for the Pairing is used on a neighbouring Artisan Evo installation

**IMPORTANT: Both the Initialisation and Pairing steps must be performed in sequence.**



### 2. Initialise the Remote Control Wireless Address.

**2.1.** Turn the Remote Control "on" by turning the lever to the "eco"  position.

- If the display shows a flashing 2-digit number, e.g. "30". Proceed to step (2.2)
- If the display shows a single flashing "0", press the Temp up  button ten times to increment the flashing number from "0" to "9", and then to a flashing 2-digit number, e.g. "30". This has now Initialised the Remote Control - proceed to Pairing (3).



**2.2. Enter Engineering Mode:** press and hold both the Temp up  and Temp down  buttons together for more than three seconds, then release.

**Note:** If "2" is displayed, press Temp down  button twice to read "0".

**2.3.** Press the Temp up  or Temp down  button to change the number until "2" is displayed, The "2" will stay displayed for ~2 seconds, and then change to a flashing "0".

# Commissioning - Max Temp Setting



2.4. Press the Temp up  button ten times to increment the flashing number from "0" to "9", and then to steady-state "2" or 'E1'. This has now Initialised the remote control.

2.5. Exit Engineering Mode: Press the Temp down  button twice to change the displayed number back to "0", and / or turn the Remote Control "off" by turning the lever back to .

## 3. Pairing the Remote Control to the Mixing Valve.

3.1. Remove the cover from the Mixing Valve and locate the block of four switches marked SW1 on the circuit board. Set switch 4 to 'ON' and loosely replace the cover.

3.2. Power up the Mixing Valve. Wait ~30 seconds for the LED to show "Yellow".

3.3. Turn the remote control "on" by turning the lever to the eco  position. Wait for the Mixing Valve LED to show "Green" (this should only take a couple of seconds). Turn the Remote Control "off" by turning the lever back to the "off"  position.

3.4. Power down the Mixing Valve. Remove the cover from the Mixing Valve, set switch 4 at SW1 to "off" and replace the cover. The Mixing Valve and Remote Control are now Paired.

## Maximum Temperature Setting

The maximum temperature is factory pre-set to 48°C. To change the maximum outlet water temperature follow the steps below.

1. Power down the Mixing Valve and remove the cover.

2. Locate the block of four switches marked SW1 on the circuit board. Position the individual switches as per the following diagrams.

**Note:** Only switches 1-3 need to be altered.

### 38°C

SW1-1 OFF  
SW1-2 OFF  
SW1-3 OFF

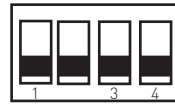

### 41°C

SW1-1 ON  
SW1-2 OFF  
SW1-3 OFF

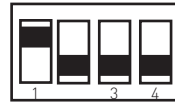

### 44°C

SW1-1 OFF  
SW1-2 ON  
SW1-3 OFF

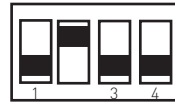

### 46°C

SW1-1 ON  
SW1-2 ON  
SW1-3 OFF

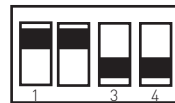

### 48°C

SW1-1 OFF  
SW1-2 OFF  
SW1-3 ON

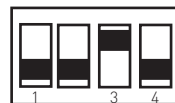

Once the switches have been altered, to the desired position the maximum temperature is set.

3. Replace the Mixing Valve cover and secure with the five fixing screws.

**IMPORTANT:** It is important to power down the Mixing Valve to change the switch settings as they are only read on power up.

# Commissioning - Functional Testing

## Checking Water / Plumbing Connections

Before using the shower for the first time the installer needs to check that the water/plumbing connections are correct.

The cold water supply pipework should only be connected to the inlet marked COLD on the Mixing Valve cover.

The hot water supply pipework should only be connected to the inlet marked HOT on the Mixing Valve cover.

Turn on the water supplies to the Mixing Valve and open the stop / service valves to the mixing valve.

Check that there are no leaks around the connections to the inlets and outlet.

## Purge Procedure

After checking the water / plumbing connections and before using the shower as normal the Mixing Valve will need to be purged. Please run through the following procedure.

1. Ensure both power and water supplies to the Mixing Valve are on.
2. Turn the Controller On by rotating the lever to any of the flow positions. The shower will run.
3. Press **+** and **-** buttons **at the same time** for 3 or more seconds then let go.
4. '0' should be displayed. If not repeat step 3.
5. Press **+** button once. '1' should be displayed.
6. The purge sequence will now run. (Short pulses of water output from the shower for about 12 seconds).

7. Once the pulsing stops, turn the Controller Off.

8. To resume normal showering, simply turn the Controller on as normal.

## Basic functional Testing

Prior to using the shower the following tests should be carried out to ensure the Mixing Valve is working correctly.

**Power on the Mixing Valve.** Check the display on the Remote Control is working.

**Check flow control.** Operate the lever to all flow positions and check for increased flow.

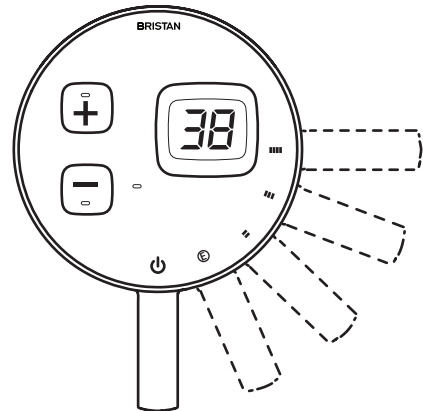

**Check Temperature controls.** Press the **+** and **-** temperature buttons to check that the temperature increases and decreases.

**Check digital display.** Ensure the temperature display increases and decreases when pressing the temperature controls.

# Operating the Shower

Please ensure the commissioning procedure has been carried out. If you did not fit this shower yourself and you are about to use it for the first time, check with the installer to ensure they have run the commissioning procedure as described on pages 19-21.

## To Start the Shower

Turn the lever (1) anti-clockwise.

## To Stop the Shower

Turn the lever (1) clockwise back to .



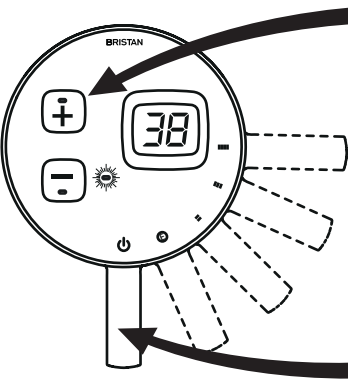

**⚠ Warning:** This appliance is not intended for use by persons (including children) with reduced physical, sensory or mental capabilities, or lack of experience and knowledge, unless they have been given supervision or instruction concerning use of the appliance by a person responsible for their safety.

**Important:** Children should be supervised to ensure that they do not play with the appliance.

## Operating the controls







**Temperature Control**

-  →  Hot
-  →  Cold

---

 Low Battery Warning Light

---

-  → Eco Water Saving Mode
-  → Low Flow
-  → Medium Flow
-  → High Flow

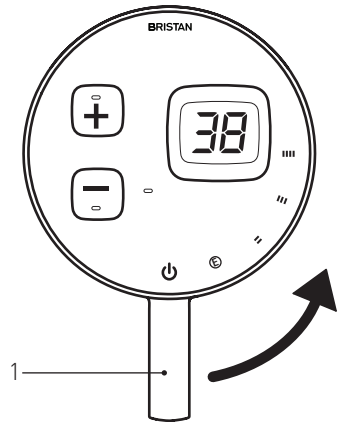

# Operating the Shower

## Memory Function

**Only available on ARDE SHCCFM C variant.**

The Memory Function allows the user to store Temperature and Flow pre-sets, and recall them to set the shower to their desired settings at a single touch of a button.

The memory Button has two settings, Memory 1 and Memory 2, indicated by two lights.

### To store a Memory Setting

1. Turn Shower On by moving Flow Lever anti-clockwise from the Off position.
2. Select desired Temperature by using "+" and "-" buttons as normal.
3. Select desired Flow by adjusting the Flow Lever as normal.
4. Press-and-hold the Memory Button "M". The Digital Display will toggle repeatedly between "1" and "2".
5. To Store in Memory 1, wait until the display shows "1" and then release the "M" button.
6. To Store in Memory "2", wait until the display shows "2" and then release the "M" button.

The desired Temperature and Flow settings are now stored in the desired Memory Setting.

### To Recall a Memory Setting

1. Turn Shower On by moving Flow Lever anti-clockwise from the Off position.
2. To recall a specific memory setting, press-and-release the "M" button until the required number ("1" or "2") is shown in the Digital Display.
3. The Controller will then set Temperature and Flow (regardless of the actual position of the lever) to the stored settings.

The Shower's Temperature and Flow can be adjusted in the normal way using the Temperature buttons and Flow lever.

Any use of the Temperature Buttons will override the Memory Temperature Setting and revert to manual temperature control.

Any use of the Flow Lever will override the Memory Flow Setting and revert to manual flow control.

# Maintenance

## General Cleaning

Your fitting has a high quality finish and should be treated with care to preserve the visible surfaces. All surfaces will wear if not cleaned correctly, the only safe way to clean your product is to wipe with a soft damp cloth. Stains can be removed using washing up liquid. All bath cleaning powders and liquids will damage the surface of your fitting, even the non-scratch cleaners.

**Note:** Never use abrasive detergents or disinfectants or those containing alcohol, hydrochloric acid or phosphoric acid.

## Cleaning the Showerhead

Your Bristan showerhead has rub-clean nozzles for easy cleaning. Simply rub your fingers across the rubber spray jets regularly and before you turn the shower on to remove any scale or debris. The hardness of the water in your area will determine how often you should clean your showerhead. Build up of scale in particularly hard water areas combined with constant use means you may need to clean your showerhead once a week. To ensure continued performance of your shower the showerhead needs to be regularly descaled.

## NRV & Filter Maintenance

The Mixing Valve is supplied with a Non-Return Valve fitted into each inlet. The filter washers which seal the inlet and connection may become scaled over in particularly hard water areas and may need cleaning on a regular basis to ensure maximum performance.

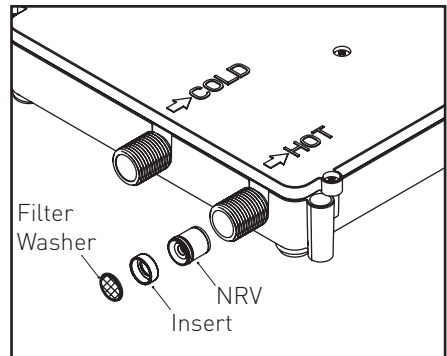

## Cleaning the Filters

Isolate both hot and cold water supplies to the Mixing Valve and remove the connections from the inlets. Run both filter washers under running water and rub your fingers over the mesh to remove any build up of scale.

## Replacing the NRVs

Isolate both hot and cold water supplies to the Mixing Valve and remove the inlet connections. Remove the filter washers and inserts from the inlets. Carefully prise out the NRVs from the inlets using a small thin bladed tool i.e. flat head screw driver. Insert new NRVs back into the inlets and replace the inserts and filter washers.

Re-fit the inlet connections ensuring they are fully tightened.

# Maintenance

## Battery Replacement

The Wireless Controller is powered by two AA batteries which are designed to last approximately 1 year based on average showering usage before they need replacing.

When the batteries run low and require replacing, the red low battery LED on the front face of the display will flash.

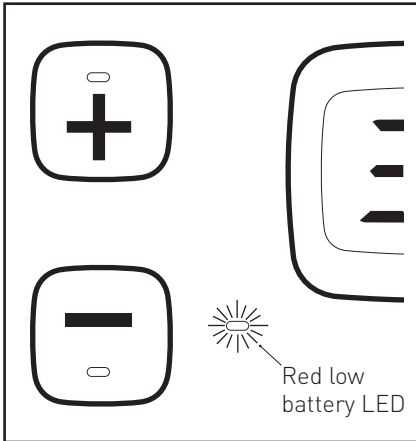

To replace the batteries the following should be carried out;

Remove the Wireless Controller from the wall bracket by twisting the locking ring clockwise to unlock the Wireless Controller from the backplate.

Remove the old batteries and replace with new AA batteries.

**Note:** Batteries must be 1.5V AA (LR6) Alkaline batteries [preferably =>2000mAh for good battery life].

**Important: Do not use re-chargeable batteries.**

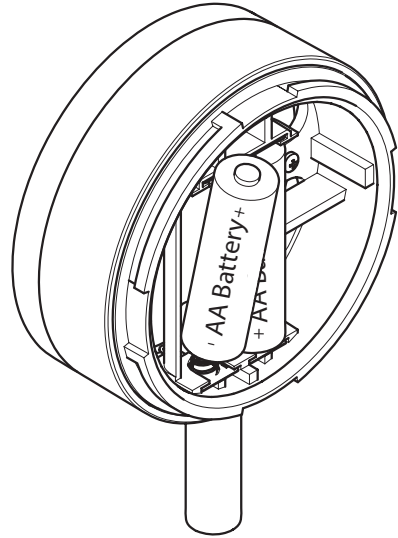

**Important:** Incorrect insertion of the batteries may damage the batteries.

Re-attach the Wireless Controller onto the locking ring once the new batteries have been inserted. Twist the locking ring anti-clockwise to lock the Remote Control in position.



# Maintenance

## Disposal and Recycling

### End of Product Life

When this appliance has reached the end of its serviceable life, it should be disposed of in a safe manner, in accordance with current local authority recycling, or waste disposal policy.

### Battery disposal

Spent batteries should not be disposed of with normal household waste. Contact your local authority for information on waste disposal and recycling.



This symbol on the product or packaging indicates that this product should not be disposed of with your other household waste. Instead, it is your responsibility to dispose of your waste equipment by handing it over to a designated collection point for the recycling of waste electrical and electronic equipment. The separate collection and recycling of your waste equipment at the time of disposal will help to conserve natural resources and ensure that it is recycled in a manner that protects human

health and the environment. For more information about where you can drop off your waste equipment for recycling, please contact your local council office, your household waste disposal service or the shop where you purchased the product.

# Troubleshooting

Symptom	Cause	Remedy
E1 displayed	Main unit is powered off.	Check power is on at the main unit and check if the LED is Green or Yellow, refer to Wireless Initialisation & Pairing of the Wireless Controller to the Mixing Valve in Commissioning Section (pages 18-20).
E2 displayed	Main unit has developed a fault.	Call Bristan Customer Services on 0844 701 6273.
E3 displayed	Hot water is isolated or has insufficient flow.	Check the hot water supply is not isolated.
	Inlet filter on the hot water supply is blocked.	Remove filter and clean, refer to maintenance section (pages 22-24).
	Hot water too hot.	Check hot water is functioning correctly, refer to specification (page 7).
	Hot water too cold.	Check hot water is functioning correctly, refer to specification (page 7).
E4 displayed	Cold water is isolated or has insufficient flow.	Check the cold water supply is not isolated.
	Inlet filter on the cold water supply is blocked.	Remove filter and clean, refer to maintenance section (pages 22-24).
	Cold water too hot.	Check cold water is functioning correctly, refer to specification (page 7).
	Cold water too cold.	Check cold water is functioning correctly, refer to specification (page 7).

# Troubleshooting

Symptom	Cause	Remedy
No or low water flow	Batteries low / run out in Wireless Controller.	Replace batteries, refer to maintenance section (page 23).
	Outlet is blocked.	Check outlet and shower rose for any blockages.
	Partially closed stop or service valve in water supply pipework to the mixing valve.	Open stop or service valve.
	Airlock or potential blockage in supply pipework.	Flush through pipework to ensure removal of any debris and any airlocks.
	Inlet filters partially blocked.	Remove filters and clean as necessary, refer to maintenance section (page 22).
	Water supply pressure too low.	Check water pressure, refer to Specification section (page 7).
Water leaking from the shower rose	This is normal for a short time after turning off.	Adjust the angle of the shower rose as necessary to vary draining time.
Maximum water temperature too hot or cold	Maximum water temperature set incorrectly.	Reset maximum water temperature, refer to Commissioning section (page 19).
Showering water temperature fluctuates significantly.	This could be due to the Mixing Valve drawing a low hot flow from certain types of Combination Boiler, and the boiler turning on/off.	Increase the flow on the Controller by moving the dial to a higher flow setting (II,III,IIII)
		Decrease the set temperature of the hot water on the Combination Boiler.
Mixing Valve is excessively noisy.	Purging procedure was not carried out when commissioning the Mixing Valve.	Purge the Mixing Valve. Refer to Purge procedure on page 20.

# Spare Parts

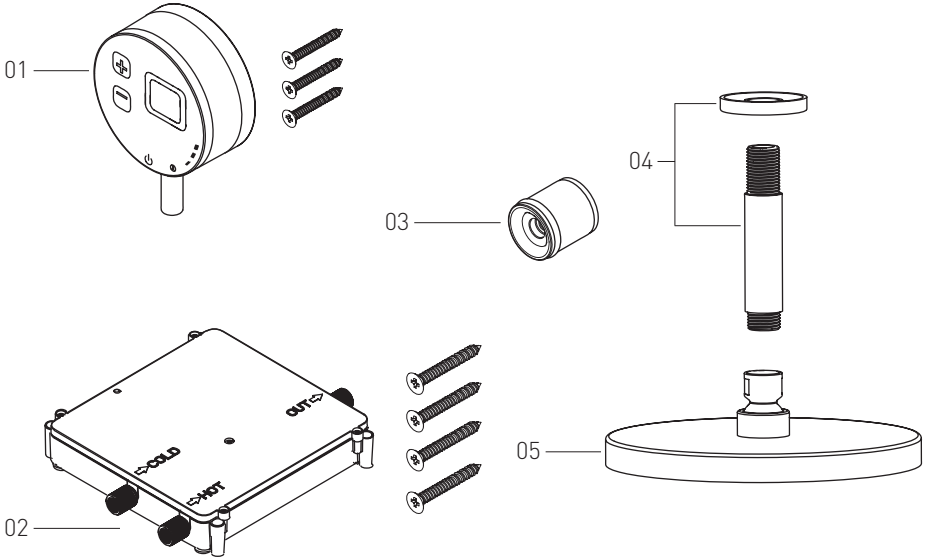

No.	Part No.	Description	Parts List	Quantity
01	ARDE WC W	Controller (White) incl. fixings	White Controller <b>x1</b> , Fixings <b>x3</b>	1
01	ARDE WC B	Controller (Black) incl. fixings	Black Controller <b>x1</b> , Fixings <b>x3</b>	1
01	ARDE WCM C	Controller Memory (Chrome) incl. fixings	Chrome memory Controller <b>x1</b> , fixings <b>x3</b>	1
02	EMV WSO	Mixing Valve incl. fixings	Mixing Valve <b>x1</b> , Fixings <b>x4</b>	1
03	NRV 08400A	NRV	NRV <b>x1</b>	1
04	ARM CFRD01 C	Arm	Arm <b>x1</b> , Shroud <b>x1</b>	1
05	FHC ABRD01 C	Rose	Rose <b>x1</b>	1

# Notes

Please use this space to add any notes you or your installer may have regarding the plumbing system / installation of this product.

# Guarantee

At Bristan, we want to make things as easy as possible for our customers. That's why we design products that are easy to fit and use, and that are quality tested to make sure they won't let you down. It's also why we offer solid guarantees on all products, effective from the date of purchase, to give you peace of mind.

Bristan's Digital Electronic Mixer Valve is covered by a **5 year guarantee**. This also includes **1 year labour cover** \* which means that, in the unlikely event that there is a problem in the first year after purchase, we'll send one of our expert engineers to fix it.

\*Labour is provided by an approved Bristan Care engineer or appointed representative. The guarantee only applies to products with a manufacturing fault. There will be a call out charge for any incidents where no fault has been found with the product, or if the issue is due to poor installation or maintenance.

## Guarantee Terms and Conditions

This guarantee is in addition to your statutory and other legal rights and is subject to the following conditions:

- The product was purchased within the United Kingdom or Republic of Ireland.
- The guarantee applies solely to the original purchaser with proof of purchase.
- The installation must allow ready access to all products for the purpose of inspection, maintenance or replacement.

- Repair under this guarantee does not extend the original expiry date. The guarantee on any replacement parts or product ends at the original expiry date.

- Any part found to be defective during the guarantee period will be replaced without charge, providing that the product has been installed in accordance with the instructions given in this guide and used as the manufacturer intended.

The guarantee does not cover:

- Damage or defects caused by;
  - General wear and tear (including special non-chrome finishes; components such as filters, seals, 'O' rings and washers)
  - Incorrect installation
  - Repair using non-Bristan parts
  - Accidental or wilful misuse
  - Corrosion and the use of inappropriate cleaning products
  - System debris including the build up of limescale (which can be controlled through regular servicing and maintenance)

- Compensation for loss of use of the product or consequential loss of any kind.

In the interests of continuous product improvement, Bristan reserves the right to alter product specifications without notice.

The Bristan Product Guarantee does not affect your statutory rights as a consumer.

# Guarantee

- **Need help?**

If this product does not function correctly when first used, contact **Bristan Care Customer Service on 0844 701 6273** where our expert team of advisors will be able to offer you help and advice.

- **Problems during the guarantee period**

In the unlikely event that you encounter any problems with the product during the guarantee period, contact **Bristan Care Customer Service on 0844 701 6273** with your proof of purchase and we will work to resolve the problem quickly.

### **Bristan Care Customer Support**

Bristan customers also benefit from the support of Bristan Care, our comprehensive customer support package which offers:

### **Technical support hotline**

(Tel: 0844 701 6273) with access to fully trained advisers who can offer installation advice, talk you through quick maintenance checks, or recommend the best course of action to fix any problems with a product.

### **Expert advice**

Find easy to follow 'how to' video guides and technical FAQs online at [www.bristan.com](http://www.bristan.com). Our guides take you step-by-step through many product installations and you can find plenty of easy guides to quick product fixes and servicing.

### **Spare parts**

We hold thousands of spares and we keep them for discontinued products for over seven years. Spares can easily be ordered online at [www.bristan.com](http://www.bristan.com) and are dispatched the same day.

### **Expert plumbing engineers**

If we can't solve the problem over the 'phone or with a spare part, then we'll send out one of our Bristan Care engineers to take a look. Bristan Care engineers provide free support for products that are within guarantee, but are also available to service products that are out of guarantee for a small charge. For details, please call **Bristan Care Customer Service on 0844 701 6273**.

Part Number: FI: ARDE SHCCF

Issue: D4

---

# BRISTAN

TAPS & SHOWERS

Bristan Group Ltd,  
Birch Coppice Business Park  
Dordon  
Tamworth  
Staffordshire  
B78 1SG  
Web: [www.bristan.com](http://www.bristan.com)  
Email: [enquire@bristan.com](mailto:enquire@bristan.com)

A Masco Company

## Useful contact details:

Customer Service:

**0844 7016273**

Customer Service Email:

**[Customercare@bristan.com](mailto:Customercare@bristan.com)**

Customer Service Fax:

**0844 7016275**

Reception:

**0844 7016274**

Join us on...

