

# IRBS2-CP

## COMMERCIAL Tap Range Infra Red Automatic Basin Spout



### Features:

- Non-touch control, using Infrared sensing technology, supports infection control measures
- Mains or battery powered options
- Automatic switch off supports water saving
- BREEAM compliant
- IRBS2-CP not suitable for fitting to metallic sinks or troughs

### Product Certifications:

WRAS Cert. Number: 1412971  
WRAS Expiry Date: 31/12/2019



For more products, visit our website:  
<http://www.bristan.com>



### Specification

<b>Product Type:</b>	Commercial
<b>Main Construction Material:</b>	Brass
<b>Mount Type:</b>	Deck Mounted
<b>Connection Inlet:</b>	N/A
<b>Connection Outlet:</b>	N/A
<b>Number of Tap Holes:</b>	1
<b>Valve/Cartridge Type:</b>	Thermostatic
<b>Plumbing System Requirements:</b>	Suitable for High Pressure Systems
<b>Working Pressure Range:</b>	Min. 1.0 Bar, Max. 5.0 Bar
<b>Maximum Hot Water Temperature: °C</b>	65
<b>Maximum Static Pressure: (bar)</b>	10
<b>Isolation Included:</b>	No

### Dimensions (measurements in mm)

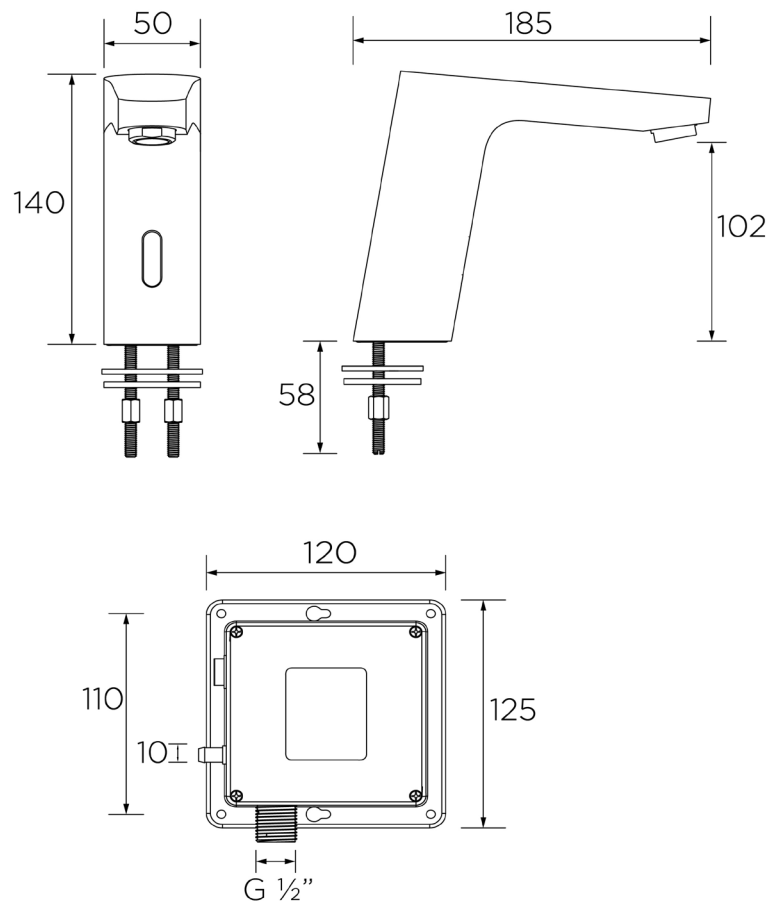

### Flow Rates (l/min)

System Pressure (bar)	1	2	3	5
IRBS2-CP	5.0	5.0	5.0	5.0

TECHNICAL  
DATA  
SHEET



**BRISTAN**  
TAPS & SHOWERS D3