

MODE

BATHROOMS

8mm Wet Room Flipper Panel

Refer To Sheet 6 For Relevant Product Codes

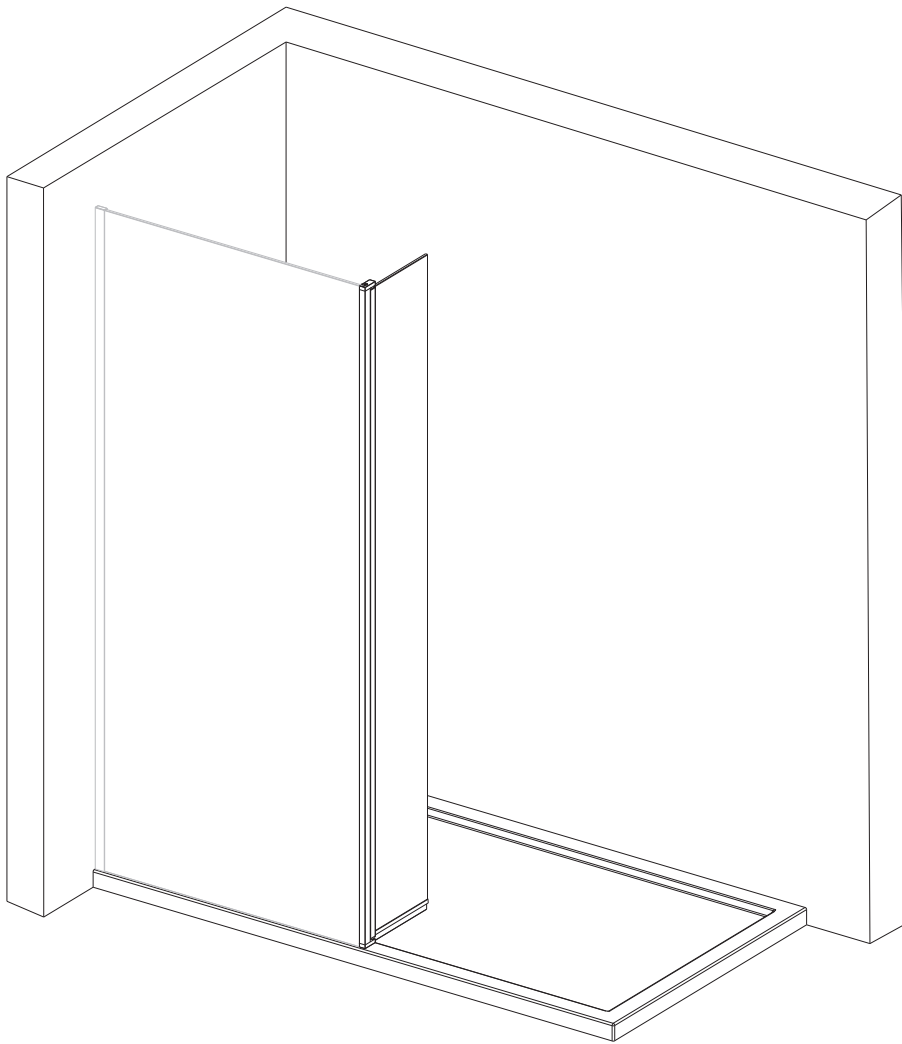

Install the main Wet Room Glass Panel
before fitting the Flipper Panel

Exclusively available @

VictoriaPlum.com

VictoriaPlum.com
0344 804 48 48

BEFORE YOU START, HERE IS SOME IMPORTANT INFORMATION

1) General Information

Please inspect this product upon delivery, any missing parts or manufacturing defects must be reported immediately to the supplier. Damage or defects reported later will not be accepted. **TAKE CARE WHEN HANDLING GLASS PARTS - AVOID HEAVY CONTACT BETWEEN THE GLASS EDGES AND ANY HARD SURFACE.**

Glass breakage claims will not be accepted after the product has been unpacked.

Please note: Aluminium is a soft metal, and undergoes a series of extrusion, fabrication, polishing and anodising processes in order to create your finished shower enclosure. Some light surface marks are normal, and is a result of the manufacturing processes. Quality control has ensured that this item is of a good standard, and is fit for purpose.









2) Additional Notes

Please read these instructions carefully before starting installation.

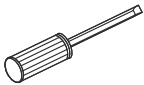
Special care should be taken when drilling walls to avoid hidden pipes or electrical cables.

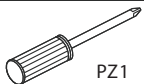
Note: this product is heavy and may require two people to install.

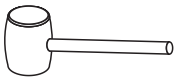
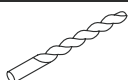
TOOLS REQUIRED

DESCRIPTION	PART IMAGE	DESCRIPTION	PART IMAGE
Tape measure		Drill	
Spirit level		Flat-head Screwdriver	
Pencil		Cross head Screwdriver	
Ø6mm Drill bit		Mallet	
Ø3mm Drill bit		Silicone Sealant	

 This product is heavy and may require two people to install.

ASSEMBLY INSTRUCTIONS - DRAWING

Flipper panel

NB: ALL MEASUREMENTS + COMPONENT SIZES QUOTED ARE IN MM.

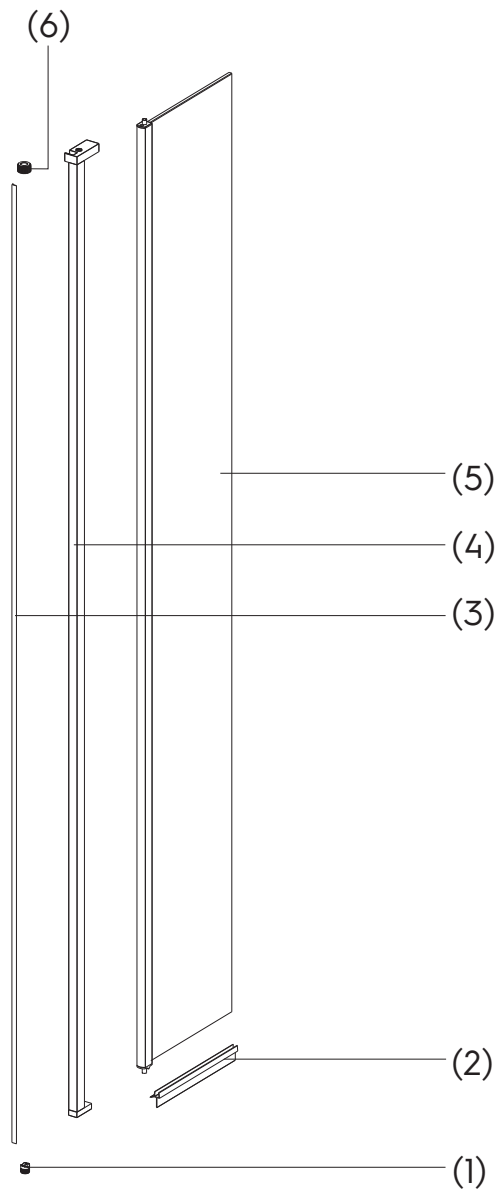

PACK I.D

- E (1) 1x Bottom Pivot Core
- C (2) 1x Bottom Seal
- E (3) 1x Wedge Gasket Seal B
- B (4) 1x Corner Post
- A (5) 1x Flipper Panel
- E (6) 1x Top Pivot Core

ASSEMBLY INSTRUCTIONS

If you require help, we advise you to contact a competent plumber

Installation Steps

FITTED WET ROOM FLIPPER PANEL DRAWING

700-1200mm C/W 300mm Flipper Panel

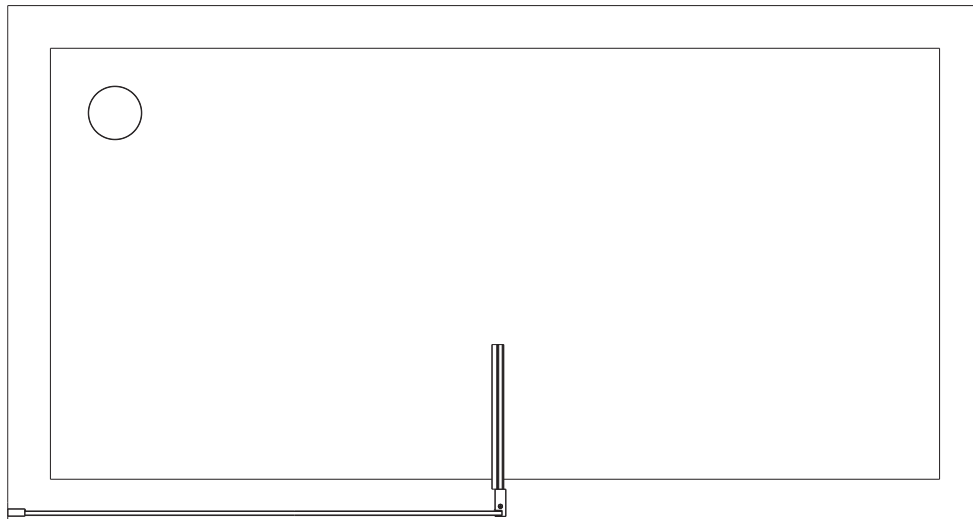

STEP 1 CHECK BOX CONTENTS ARE CORRECT AND THEN MEASURE KEY COMPONENTS.

Measurement Matrix (before assembly)	Dimension in mm
Units supplied loose for self assembly	V8SFP301950
Flat fixed panel glass	N/A
Flat fixed panel glass (including fixed panel profiles if attached)	274x1912x8
Wall profile	N/A
Corner post	1928x24

STEP 2 CHECK LEFT HAND OR RIGHT HAND FITTING

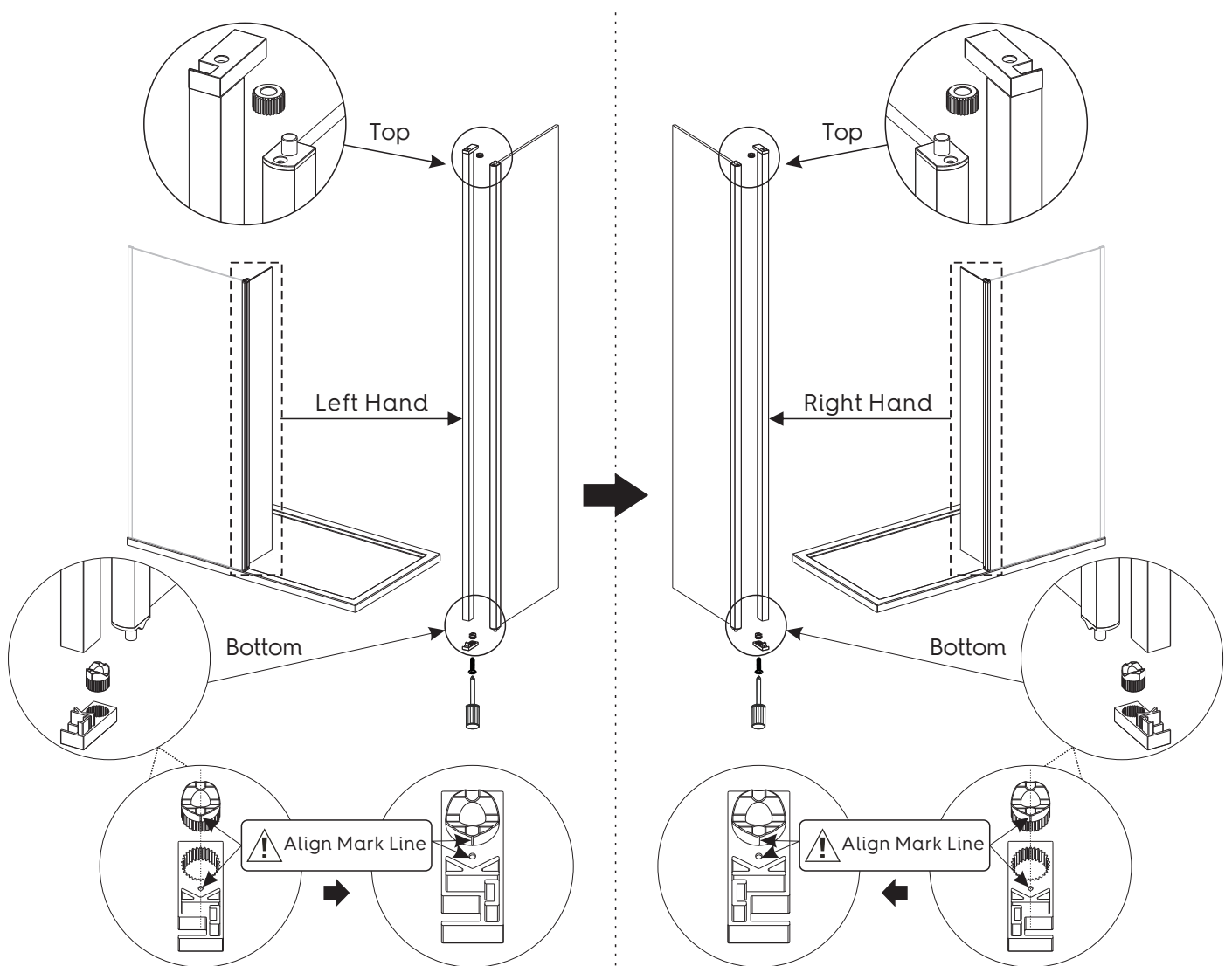

STEP 3 FITTING THE SEALS AND TOP CAP

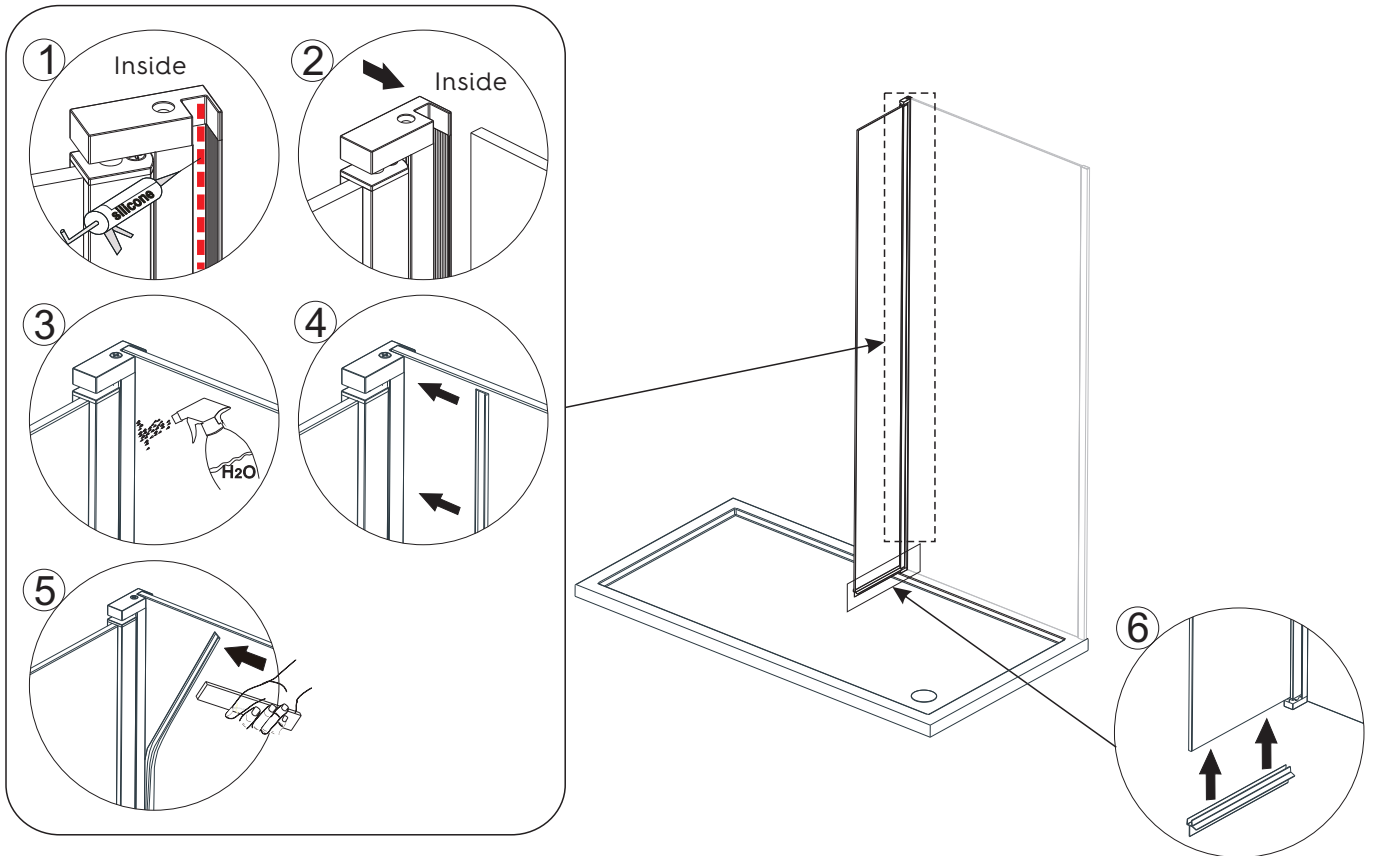

Allow 24 hours for silicone to dry before use.

CARE AND MAINTENANCE

1) AFTER CARE INSTRUCTIONS

Regularly clean your shower product with warm soapy water to prevent lime scale build up. Do not use abrasive cleaning fluids or materials, or strong chemical cleaners as this will damage the product surface.

2) MAINTENANCE

Clean the plastic parts with a cloth and mild detergent. Never use any abrasive creams, dissolvents, acetone or detergents and disinfectants that contain chlorine. The supplier accepts no liability for any type of use of care other than those contained in these instructions. The supplier reserves the right to introduce technical changes without notice.

COMMITMENT TO QUALITY

It is our intention that the quality and functions of this product are of the highest standard. If you require help we advise you firstly contact a competent plumber. However we understand that this may not always be the case, so should you experience any problems please contact our customer services quoting the following:

Product name: 8mm Wet Room Flipper Panel

Product code: V8SFP301950

Customer help line number: 0344 804 48 48



Victoria Plum Limited, Bridgehead Business Park
Hesle, HU13 0DG

17

EN 14428 : 2015
DOP No.:J170320002-1

Shower enclosures with aluminium
profiles and safety glass

Essential characteristics	Performance	Harmonised technical specification
Cleanability	Pass	Clause 4.2 of EN 14428:2015
Impact resistance/shatter properties	Pass	Clause 4.3 of EN 14428:2015
Durability	Pass	Clause 4.4 of EN 14428:2015

The packaging you have received with your product is 100% recyclable.
It must be disposed of in a safe and environmentally friendly way.
We suggest you take it to the local landfill site and discard in the designated bins.